









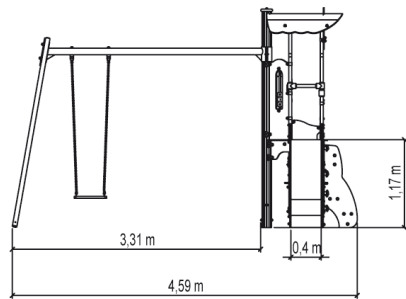
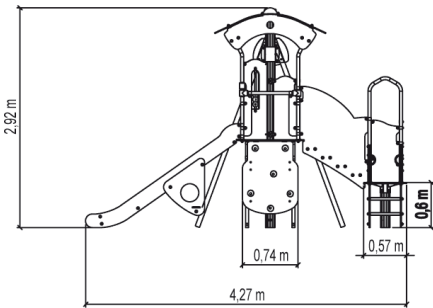

 **2+** |
  **15** |
  **1,4m** |
  **1 = 4,59m 2 = 4,28m 3 = 2,9m**

 **Motor disability**
Sensorial disabilities
Learning disabilities

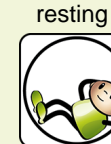

Play value : 10

 climbing x1	 sliding x1	 meeting x2	 resting x1	 handling x1	 swinging x1	 taking shelter x1	 climbing x2
---	--	--	--	---	--	---	---

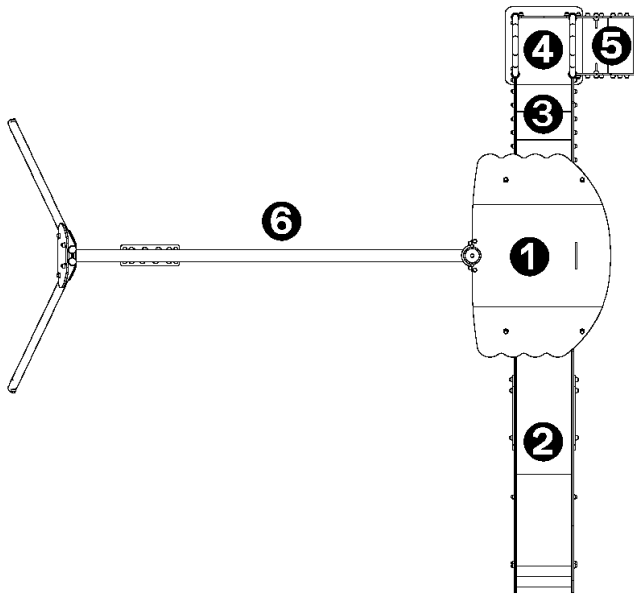

- ① Tower HT: 1.17m
- ② Slide HT: 1.17m
- ③ Connecting staircase
- ④ Platform HT: 0.6m
- ⑤ Steps
- ⑥ Swing
- ⑦ Climbing wall
- ⑧ Seat
- ⑨ Counting panel

Installation of equipment

Impact area =

- Impact area
- Free space

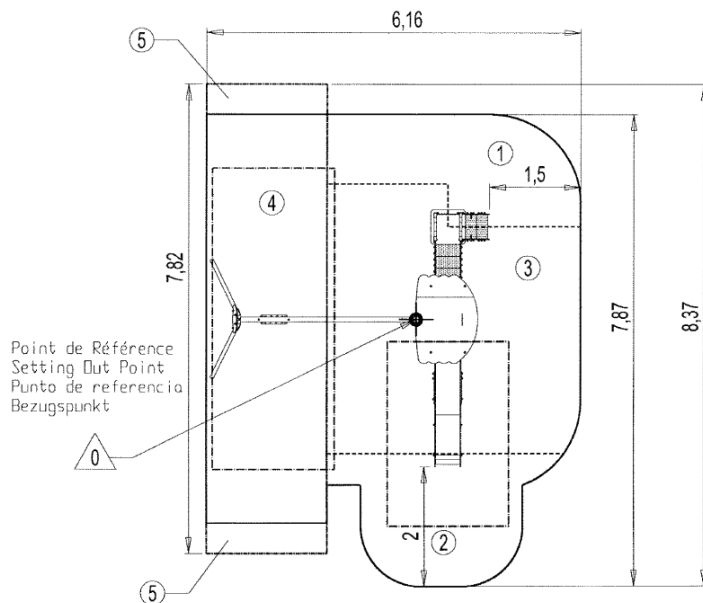

1	0,6m	6m ²
2	1m	6m ²
3	1,17m	17,5m ²
4	1,4m	13,5m ²
5	<0,6m	2m ²



2



14h00



0.2m³



43m²



342kg



33kg

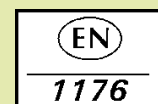

Proludic

2009-01-01